

TOP VIEW

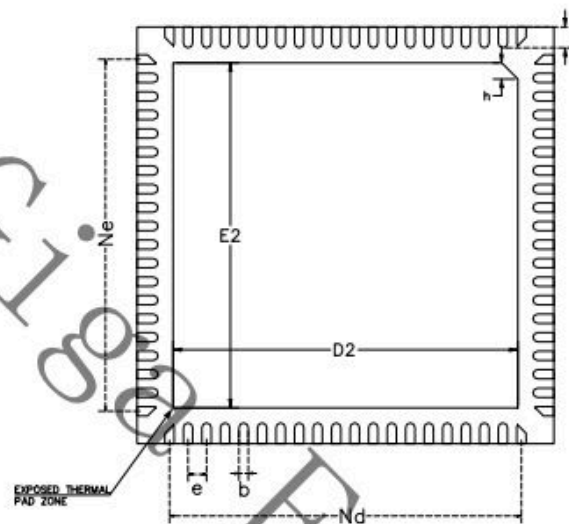

BOTTOM VIEW

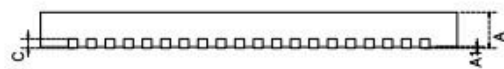

SIDE VIEW

SYMBOL	MIN	NOM	MAX
A	0.7	0.75	0.8
A1	-	0.02	0.05
b	0.15	0.2	0.25
c	0.18	0.2	0.25
D	8.90	9.00	9.10
D2	7.35	7.45	7.55
e	0.4BSC		
Nd/Ne	7.6BSC		
E	8.90	9.00	9.10
E2	7.3	7.4	7.5
L	0.4	0.45	0.5
h	0.3	0.35	0.4
L/F载体尺寸 (mm)	7.7*7.7		

NOTES:  
 1. ALL DIMENSIONS REFER TO JEDEC STANDARD MO-220(VHHE)  
 2. DIMENSION D DOES NOT INCLUDE MOLD FLASH  
 3. DIMENSION E1 DOES NOT INCLUDE MOLD FLASH  
 4. FLASH OR PROTRUSION SHALL NOT EXCEED 0.25mm PER SIDE.



上海季丰电子科技有限公司  
 GIGA FORCE ELECTRONICS CO., Limited

制图	王磊	Title	QFN80L (9X9X0.75) -P0.4	
核准	何桂港	POD No	POD-SHJF-29	
日期	2022. 3. 6	DIMENSIONS IN:	mm	Rev: A